

reliable ^ professional ^ achievable



11 Height Safety

2014 edition

www.lifting.com.au



Height Safety



Since 1972 Robertsons has supplied a variety of industries with some of the world's best and most advanced height safety equipment and systems.

Our range of height safety, fall protection and rescue equipment enables superior performance and unparalleled safety in elevated conditions including work positioning, work restraint, vertical rescue, confined space entry, rope access, rescue, fall arrest, and emergency response.

Height Safety Overview	344
Risk Assessment & Fall Arrest Considerations	345
The A,B,C,D,E & K of Height Safety Equipment:	
A – Anchor Points & Systems	348
Structural, Concrete & Roof Mount Anchors	348
Other Specialised Anchors	350
Horizontal Safety Lifelines & Systems	351
Anchor Straps	352
Lifelines	353
B – Body Harnesses	354
DBI-Sala ExoFit NEX™ Harnesses	355
DBI-Sala DELTA™ II Harnesses	359
DBI-Sala Fall Protection Kits	362
DBI-Sala Miners Belts	363
B-Safe Harnesses	364
C – Connectors	372
Karabiners & Hooks	372
Rope Grabs & Lifelines	373
Vertical Systems & Pole Straps	374
Energy Absorbing & Specialty Lanyards	375
Self Retracting Lifelines and Accessories	378
D – Descent, Rescue & Confined Spaces Equipment	383
Tripods	383
Emergency Retrieval Self Retracting Lifelines	383
Winches	383
Bosuns Chairs/Spreader Bars	384
Confined Space Equipment	384
Fall Arrest & Side Entry Systems	386
Rescue Systems	386
E – Engineered Systems	389
Uni Horizontal Safety System	389
Unirail Horizontal Safety System	390
Flexiguard Access Systems	391
K – Kits & Accessories for Height Safety Equipment	393
Harness & Roofers Kits	393
Construction & Electrical Safety Harness Kits	394
Accessories	395

Height Safety Overview

We offer our clients:

- › Full assessment of your work site
- › Full engineered design of your height safety system suited specifically to your needs
- › Installation of systems by accredited and trained installation teams
- › Certification and documentation compliant to the Australian Standards and State Workplace Safety Regulations
- › Full training of your staff in system use by nationally accredited trainers

With over 40 years experience in delivering height safety services you can be confident Robertsons will provide you with compliant, cost effective solutions tailored to your specific work requirements.

Design, Layout and Installation of Height Safety Systems

We specialise in the design, layout and installation of height safety systems and have installed these for the following applications/industries:

- › Storey Bridge Adventure Climb
- › Councils
- › Defence Force Operations
- › Power stations
- › Oil refineries
- › Shopping centres
- › Schools
- › Aircraft maintenance
- › High rise apartments and commercial buildings

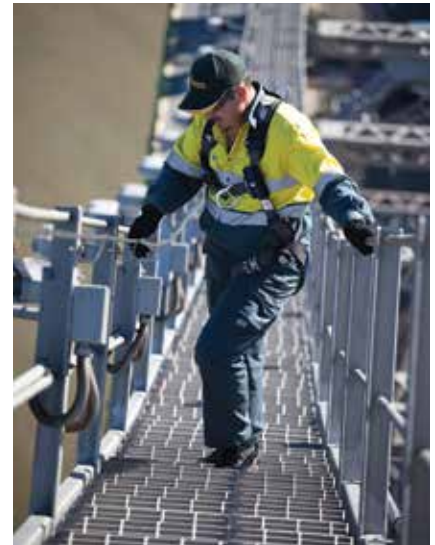

Inspections and Re-Certifications

We can supply full reports and certificates to comply with Australian Standard – AS1891.

Training

Nationally recognised competency based training courses are offered by Robertsons to customers who would like to have their staff trained in height safety. The training courses incorporate both theory and practical demonstrations and cover areas such as fall arrest, confined space non entry rescue techniques and correct breathing apparatus requirements. Courses can be undertaken at our training facility in Loganholme, (Brisbane South) or on-site at the customer's premises.

Some of our specific courses include:

- › Height Safety Operator and Height Safety Refresher Courses
- › Confined Space Non Entry/ Entry & Breathing Apparatus Courses
- › Tower and Pole Rescue
- › Emergency Escape
- › Rope Access Awareness Level 1 & 2: Course 12
- › Height Safety Supervision & Management

Authorised Service Agents

Robertsons are authorised service agents for DBI-SALA and Protecta and can carry out mandatory annual servicing (as per Australian Standard AS1891) on fall arrest blocks, winches and rescue equipment.



Risk Assessment & Fall Arrest Considerations

A risk assessment should be conducted prior to any work being carried out to identify the hazards that exist and the risks that they pose.

Simple Risk Assessment Procedure (sample only)

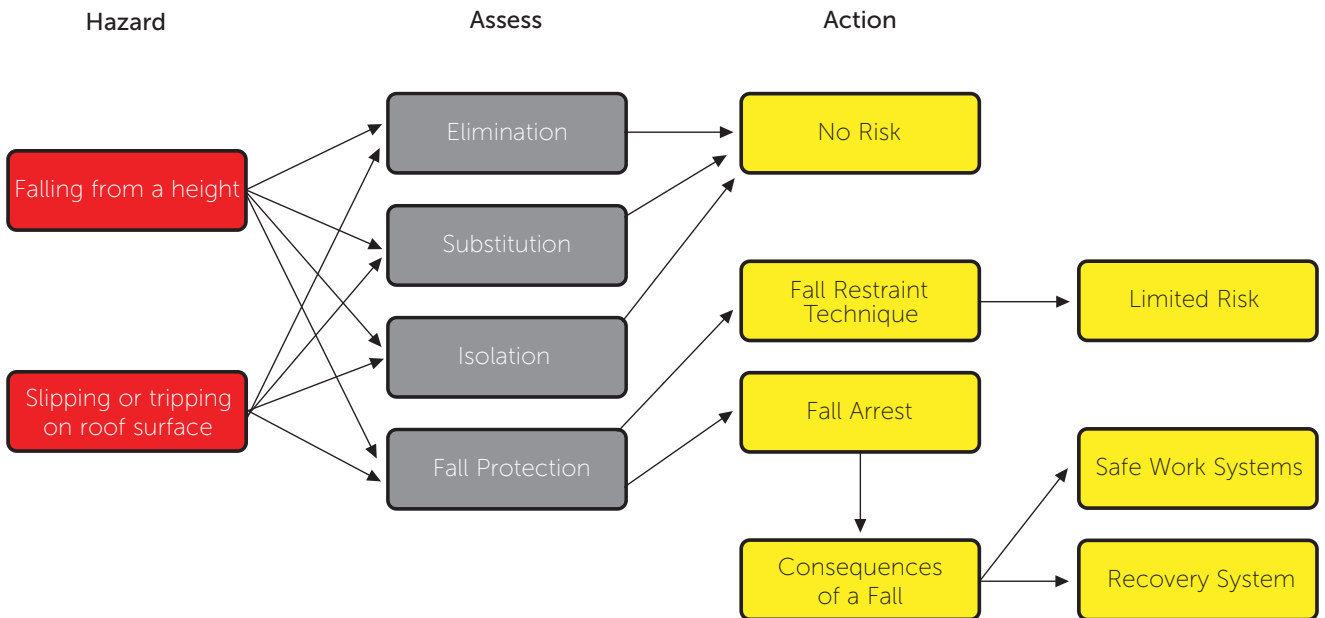

This table is a sample only as many other hazard factors can and will come into account. Other issues to be addressed at this stage include, but are not limited to: Nature of the work, surface materials, fragile roofing material, personal training levels, competency, weather conditions, surface conditions, etc. Reference should be made to AS/NZS1891.4 for the correct use,

Selection and Maintenance criteria for Height Safety Systems.

It is recommended that wherever possible a "Restraint technique" system is used. This is a system where a person using fall arrest rated equipment, is prevented from reaching a position from where a fall is possible.

The image to the right is of a working group undertaking a pre work risk assessment and inspecting all equipment to be used on the job.

The equipment inspection is recorded on a register, and with the work method statement discussed in a toolbox talk.

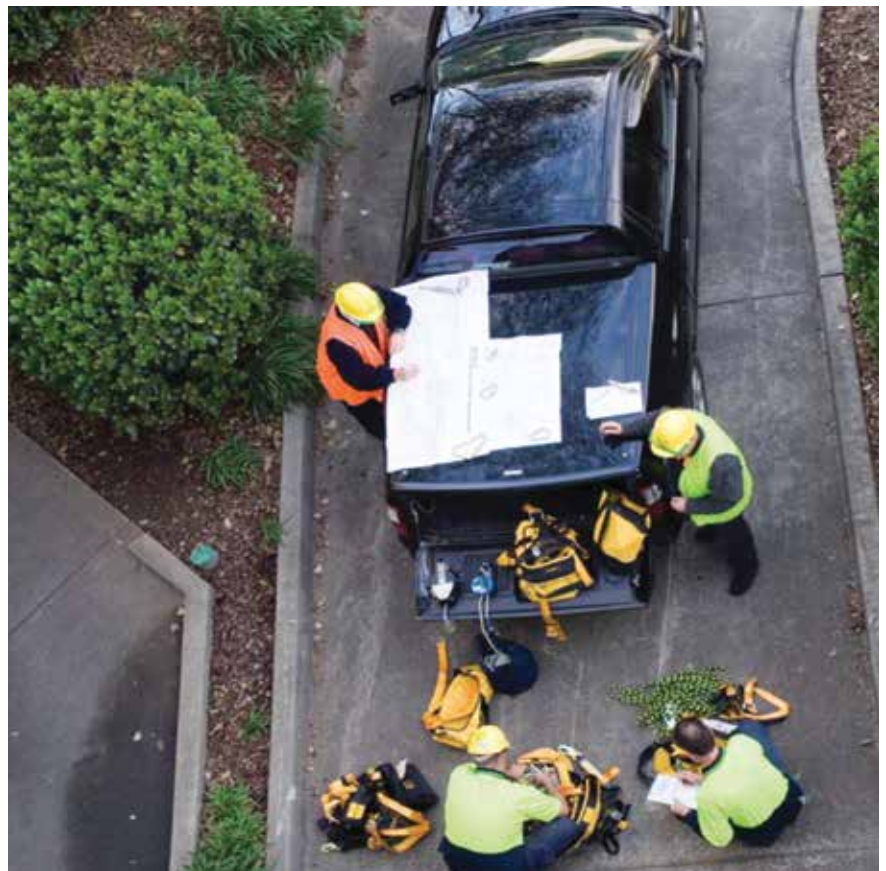

Risk Assessment & Fall Arrest Considerations

General Principles of Safely Working at Heights

Work sites today pose hazards that can cause serious harm. The responsibility to end each and every day safely rests not only with your employer but more importantly with yourself. In today's workplace you need to be aware of the hazards that

are present and look at the ways that these hazards can be identified.

This principle has been used in many very high risk occupations for some time, and the benefits have been rewarding with a noticeable reduction in accident statistics.

A risk assessment – hazard reduction procedure is covered on the previous page and Robertsons recommend that all users of height safety equipment, should use a risk assessment procedure to identify the hazards that could cause injury.

General Terminology used in Fall Prevention

Restraint Technique – To control a person's movement by means of a combination of a harness, and an energy absorbing lanyard that will physically prevent the person from reaching a position at which there is a risk of a free fall.

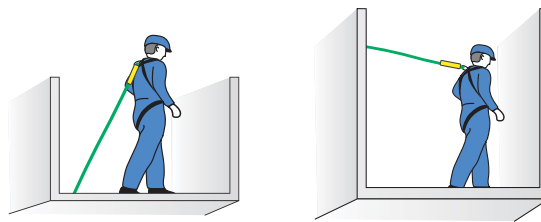

Restrained Fall – A fall or the arrest of a fall where the person suffering the fall is partially restrained by a restraining device such as a pole strap or is sliding down a slope on which it is normally possible to walk without the assistance of a hand rail or hand line.

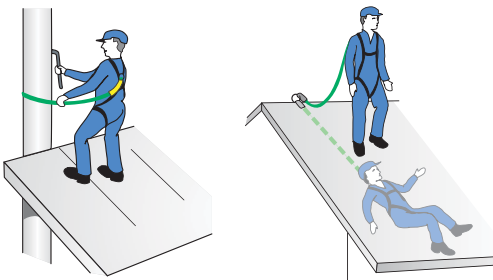

Limited Free Fall – A fall or the arrest of a fall where the fall distance prior to the system taking the load, and the maximum distance of any free fall component will not exceed 600mm.

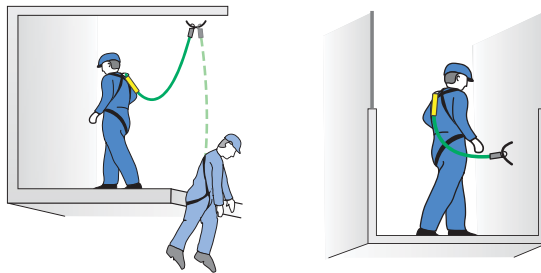

Free Fall Arrest – A fall or the arrest of a fall where the fall distance before the fall-arrest system begins to take any loading, is in excess of 600mm either vertically or on a slope which is not possible to walk without assistance of a handrail or hand line. Maximum Free Fall distance permitted is 2000mm, with a shock absorbing lanyard. (Please note fall clearance requirements on page 360)

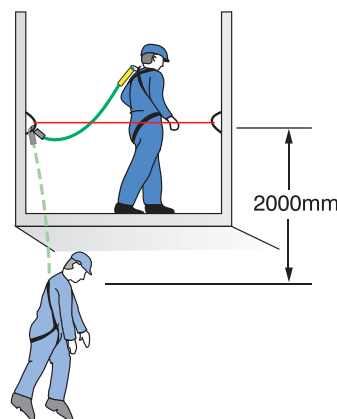

Risk Assessment & Fall Arrest Considerations

When using fall arrest type equipment, it is essential that there be adequate clearance under the area of work so that in the event of a fall, the user will not strike the ground or any other hazardous objects during the fall.

If it is assessed that the occurrence of a fall would endanger the user then other alternatives of fall protection systems must be considered. This may include the use of shorter shock absorbing lanyards, retracting lanyards or adjustable lanyards. In each case

the fall clearance must be identified and the hazards associated with fall clearance eliminated.

With the reduction of free fall distances other benefits can occur, if the free fall distance is reduced then the load on the system and the person could be reduced, also the recovery method and time may be significantly reduced if the users fall distance is kept to a minimum.

Wherever possible the attachment point for a fall arrest system should be

located above the users attachment point on the harness, when this is not possible the shock absorbing lanyard length must be reduced to ensure that the maximum fall distance of the user is limited to 2000mm. A user should never climb above the attachment point using a fall arrest shock absorbing lanyard as this only adds to the free fall distance and consequently adds to the overall shock load on the system, and the person.

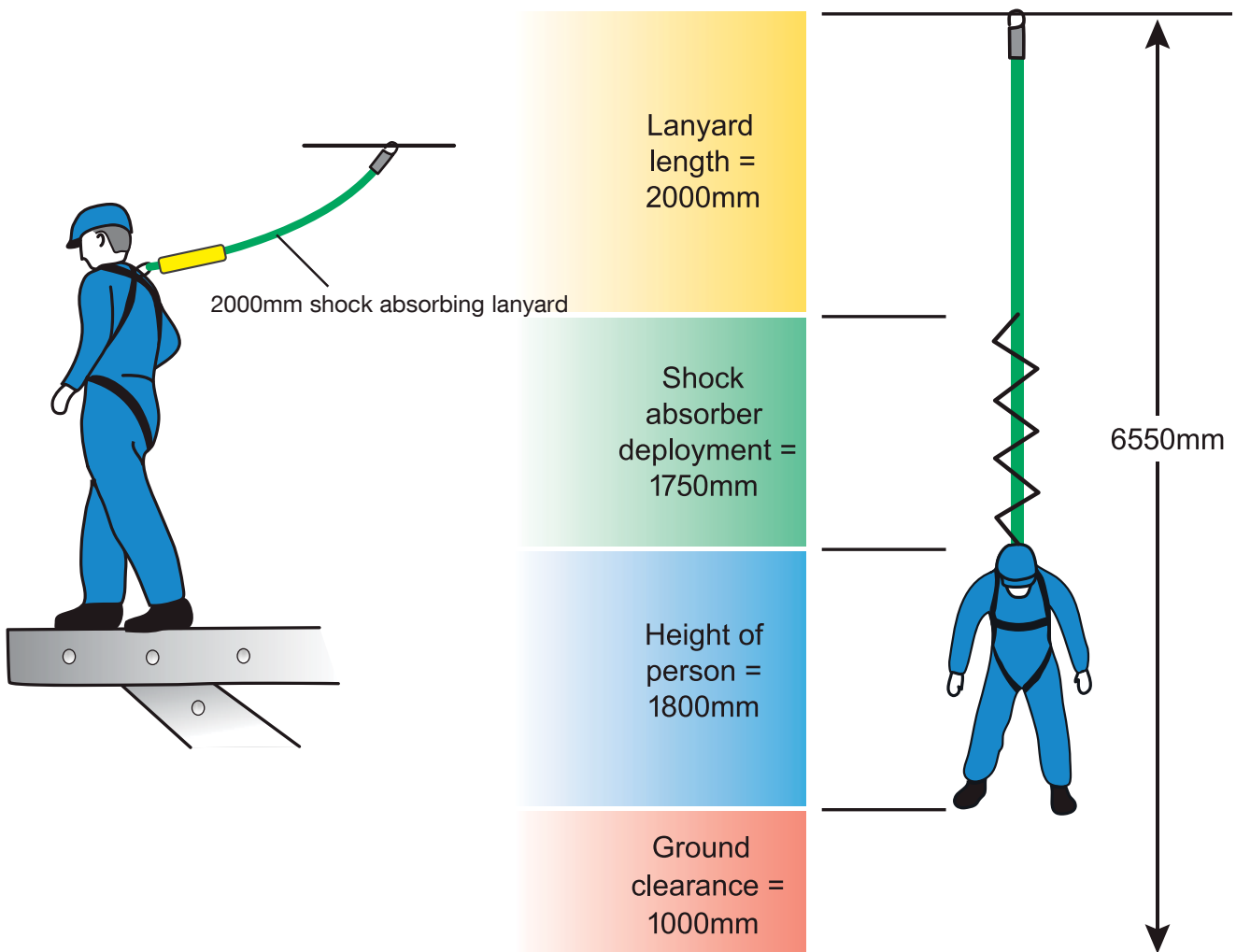

A – Anchor Points



Anchors

DBI-SALA Structural Mount Anchors

Product Code	Description	Permanent	Temporary	Removable	Anchor Rating
2100101	Saflok® Toggle Anchor		✓		22kN
2101630	D-ring Anchor, with anchorage plate	✓			22kN
9501683	D-ring Anchor	✓			22kN



2100101



2101630



9501683



DBI-SALA Concrete Mount Anchors

Product Code	Description	Permanent	Temporary	Removable	Anchor Rating
2100085	Saflok® Concrete Wedge Anchor		✓		22kN
2101004	Concrete Detent Anchor	✓		✓	22kN
2104560	Concrete D-ring Anchor	✓	✓		22kN



2100085



2101004



2104560

PROTECTA Anchorage Devices



Product Code	Description	Permanent	Temporary	Removable	Anchor Rating
AJ703A	Raildog® Rail Anchor			✓	
AJ720A	Concrete Anchor	✓			22kN
AM210	Fixed Anchorage Plate	✓			15kN
AM211	Fixed Anchoring Ring	✓			15kN



AJ703A



AJ720A



AM210



AM211

A – Anchor Points



DBI-SALA Roof Mounted Anchor Bolts

Product Code	Description	Permanent	Temporary	Removable	Anchor Rating
L4543	Purlin Mounted Anchor, for steel roofs	✓			15kN
L4544	Truss mounted Anchor, for steel or tiled roofs	✓			15kN
L4548	Multipurpose Surface Mounted Anchor	✓			15kN
L4550	Low Profile Purlin Mounted Anchor, flat pan application	✓			15kN
L4551	Low Profile Purlin Mounted Anchor, corrugated iron application	✓			15kN
L4552	Low Profile Purlin Mounted Anchor, spandek application	✓			15kN



L4543



L4544



L4548



L4550



L4551

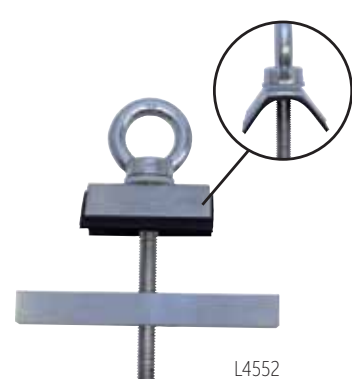

L4552

Safety Link FrogLink Roof Anchor

The FrogLink is an anchor point for use on metal roof profile where access to timber is difficult. Will arrest from any direction.

- › Rated at 22kN.
- › 316 Stainless Steel construction.
- › Tested to Australian and New Zealand Standard AS/NZS 1891.4.
- › Designed to suit all roof profiles with a single row of holes for rivets.
- › Energy absorbing anchor.



A – Anchor Points



Other Specialised Anchors

Product Code	Description	Permanent	Temporary	Removable	Anchor Rating
2103143	Beam Trolley Anchor (Adjustable) A robust non-penetrating overhead anchor point for structural steel such as I-beams that rolls across the beam on its wheels and follows the worker as they walk below the beam.		✓	✓	22kN
2104700	Glyder™ 2 Sliding Beam Anchor (Adjustable) A non-penetrating anchor point for structural steel such as I-beams that slides across the beam on its wear pads and follows the worker as they walk along the beam, can be used overhead or at your feet.		✓	✓	22kN
2108406	Fixed Beam Anchor (Adjustable) A non-penetrating anchor point for structural steel such as I-beams. Ideal as a single-person anchor point or as end-anchors for a Sayflin™ horizontal lifeline system		✓	✓	22kN
2100080	Door/Window Jamb Anchor Designed to install between the vertical sides of a door or window frame to provide a non-penetrating anchor point.		✓	✓	16kN
2104530	First-Man-Up™ Systems A safe and easy way to anchor a fall protection device to an overhead location. 1.8 - 3.6m working length				N/A
2104531	First-Man-Up™ Systems A safe and easy way to anchor a fall protection device to an overhead location. 2.4 - 4.8m working length				N/A
2200095	Vacuum Anchor System The Mobi-Lok™ provides a non-penetrating anchor point for attachment to smooth, non-porous surfaces such as aircraft, railway cars and tanks.			✓	TBA
762998	Anchor On the Go™ An easy to use, economical temporary anchor for metal roofs.		✓	✓	15kN



A – Anchor Points

Horizontal Safety Lifelines and Systems

DBI-SALA SayflinTM Temporary Lifeline Rope Systems



The SayflinTM Temporary Lifeline Rope System is designed as an anchoring means for one or two personal fall arrest systems. Use Sayflin where horizontal mobility and fall protection are required.

- › Temporary horizontal lifeline (THLL) system, available in system lengths of 15, 20, 25, 30 and 35 metres

- › SayflinTM THLL system is a complete kit provided in its own carry bag that is easily installed with no special tools or equipment
- › Lightweight and extremely portable, allowing you to move and reuse the system over and over again
- › Complete with rope lifeline assembly, and tensioning device for ease of use
- › Includes two anchor straps to anchor the system to a structure
- › Two attachment runner pulleys provided for connection of personal fall arrest system to life line
- › Suitable for multi person use (rated for two persons)
- › Meets or exceeds all applicable industry standards.

Product Code	Description
P-2000-15	15m
P-2000-20	20m
P-2000-25	25m
P-2000-30	30m
P-2000-35	35m



P-2000-20



The SecuraSpan[®] Temporary Horizontal Lifeline

The SecuraSpan[®] horizontal wire cable lifeline (HLL) system was developed to provide an economical and safe solution to non-engineered homemade HLL systems. The system and all components have been rigorously tested to exceed the unique dynamic, performance and strength requirements involved with horizontal systems. The extremely lightweight stanchions can be configured into a complete engineered fall protection system for steel erectors.

- › Suitable for up to 6 users (2 per span)
- › Installed with no special tools or equipment – No system “tie-back” is necessary!
- › Lightweight stanchions incorporate a single clamp design with a simple wing nut that allows for fast attachment and easy adjustment
- › Complete with two stanchions with built-in fastening system for quick and easy installation (intermediate stanchions available for multi-span systems)
- › By-passable design and unlimited system length provides 100% protection and flexibility
- › Includes a Zorbit[®] energy absorber with turnbuckle for added safety and tensioning of the system.

Product Code	Description
7400120	6m
7400130	10m
7400140	13m
7400150	16m
7400160	20m



7400120

A – Anchor Points

The EZ-Line™ Retractable Horizontal Lifeline

EZ-Line™ is a user friendly horizontal lifeline system which is easy to install, remove and store. EZ-Line's retractable design allows the user to quickly and efficiently set-up and dismantle any length of system quickly.



7605061

Product Code	Description
7605061	15m

Anchor Straps

Tie-off adaptor with interlocking rings. 75mm web

Product Code	Description
E849-005	0.5m
E849-008	0.8m
E849-010	1m
E849-012	1.2m
E849-015	1.5m
E849-020	2m



E849-010



Round strap. 45mm web

Product Code	Description
E87-006	0.6m
E87-010	1m
E87-012	1.2m
E87-015	1.5m
E87-020	2m



E87-020



E88-012

Flat strap. 45mm web

Product Code	Description
E88-006	0.6m
E88-012	1.2m
E88-015	1.5m

Anchor strap with interlocking rings

Product Code	Description
AM500/100AU	1.0m
AM500/150AU	1.5m



Webbing round strap

Product Code	Description
AM450/120AU	1.2m
AM450/150AU	1.5m



AM500/150AU



AM450/120AU

A – Anchor Points

B-Safe Temporary Horizontal Safety Line



Product Code	Description
BK040020	Webbing Temporary Life Lines– Suitable for 1 person. An easily installed 20m heavy duty webbing temporary lifeline for horizontal mobility. Lightweight and ideal for general construction, maintenance and situations where the worksite is constantly evolving.
BK040120	Webbing Temporary Life Lines – Suitable for 1 person. Complete with tie off equipment. Easily installed and tensioned.



BK040020



BK040120

B-Safe Rope Temporary Horizontal Life Line

A temporary horizontal rope lifeline provides the operator the benefit of horizontal mobility.

- › Easily tensioned
- › Rugged yet lightweight system
- › Easy to install
- › Suitable for general construction, maintenance and situations where the work conditions may vary day to day.
- › Rated for two (2) operators.



BK030030

Product Code	Description
BK030030	30m length Rope Temporary Life Line
BK030040	40m length Rope Temporary Life Line
BK030050	50m length Rope Temporary Life Line



Harness Fitting Instructions

1. Inspect the harness before use

All fall protection equipment should be inspected by the user prior to and after each use. A detailed inspection should also be performed by a Height safety Equipment Inspector every six months as per AS/NZS 1891.4.

Harnesses should be inspected for felt pen markings on load bearing webbing, cuts, burns, discolouration, excess dirt or wear, knots, other damage and activation of the impact indicator where applicable (Fig. A).

All labels must be present. Hardware such as D-rings, snaphooks and buckles should be free of cracks, corrosion, deformation, burrs, missing parts, or other damage and/or wear (Fig. 1B & 1C).

If there is ever any sign of an unsafe condition or if the harness shows signs that it has been used to arrest a fall it should be immediately withdrawn from service & destroyed.

2. Getting Started

Vest – Hold harness by back D-ring, ensure all buckles are undone and ensure there are no tangles in the webbing. Holding the shoulder straps slip harness over arms and onto shoulders like a jacket. Check straps are not tangled and hang freely. (Fig. 2A & 2C)

Crossover – Holding harness on your right ensure all buckles are undone and straps aren't twisted. Slip the harness over your head from right to left and attach the frontal attachment strap on your left side. Front D-ring should be positioned at the base of the rib cage (sternum) so that the shoulder straps will not slip off the shoulders. (Fig. 2C & 2D)

3. Sub pelvic strap

The positioning of the sub-pelvic strap is critical.

Vest – Adjust the shoulder straps to ensure the sub-pelvic strap is positioned directly below the buttocks. Ensure the straps are adjusted to the same length on each side. (Fig. 3A)

Crossover – Adjust sub pelvic strap to sit directly below the buttocks by tightening the upper right hand buckle (to raise both the sub-pelvic and front D-ring) and then the lower left side frontal adjustment strap. (Fig. 3B)

Note: *This strap may need to be fed through the frontal D-ring.*

4. Leg Straps

Pass left leg strap between legs ensuring it is not twisted and fasten with relevant buckle on left hand side. Repeat procedure with right side.

Make sure webbing does not cross between legs. Adjust the leg straps so that a flat hand (Not a Fist) can be placed between the leg and the leg strap (Fig. 4A).

5. Chest Strap & Waist belt

Note: *Not all models have a chest strap or waist belt.*

Position chest strap across the middle of the chest, approximately 3 finger widths above the base of the sternum. Shoulder straps should be vertical, not pulled into centre of body. Connect the waist buckle ensuring that the webbing straps are not twisted and kept loose so that the belt does not impact a worker during a fall.

6. Final Adjustments

The harness should be comfortable without undue pressure on the shoulders, thighs or pelvis. You should

still have your full range of motion with the harness fitted correctly. The dorsal D-ring should be positioned centrally between the shoulder blades.

Keepers should be positioned properly to prevent webbing slippage and entanglement. If two keepers are present, one should be positioned tight against the buckle to keep it in adjustment and the second to store the extra webbing.

For full user information or to obtain a copy of the relevant instruction manual call your nearest Robertsons branch.



B – Body Harnesses



DBI-SALA ExoFit NEX™ Harnesses

ExoFit NEX™ Riggers Harness

Ideal for use as a professional general purpose harness in rigging, ladder climbing and confined space access work.

Front and rear Tech-Lite™ aluminium D-rings, Duo-Lok™ quick-connect buckles, Revolver™ vertical torso adjusters, non-slip hybrid comfort padding, suspension trauma straps, confined space loops, impact indicator, REPEL™ technology webbing.



Product Code	Description
603S2018	Small
603M2018	Medium
603L2018	Large
603XL2018	Extra Large

ExoFit NEX™ Confined Space Harness

Ideal for the professional performing confined space access work, ladder access and rescue.

Front, rear and side Tech-Lite™ aluminium D-rings, Duo-Lok™ quick-connect buckles, Revolver™ vertical torso adjusters, nonslip hybrid comfort padding, wide padded lower back/hip pad, suspension trauma straps, confined space loops, impact indicator, REPEL™ technology webbing



Product Code	Description
623S2018	Small
623M2018	Medium
623L2018	Large
623XL2018	Extra Large



ExoFit NEX™ Wind Energy Harness

Ideal for the professional wind tower worker, uniquely designed with specialised features for wind energy needs.

Front and rear Tech-Lite™ aluminium D-rings, side D-rings, Duo-Lok™ quickconnect buckles, Revolver™ vertical torso adjuster, wide padded lower back/hip pad, removable tongue buckle waist belt, dorsal webbing and lumbar protectors, built in radio holster, tool D-rings, non-slip hybrid comfort padding, suspension trauma straps, impact indicator REPEL™ technology webbing.



Product Code	Description
603S4044	Small
603M4044	Medium
603L4044	Large
603XL4044	Extra Large

B – Body Harnesses



ExoFit NEX™ Cross-Over Harness

Ideal for the professional performing roof construction, maintenance and ladder access work.

Front and rear Tech-Lite™ aluminium D-rings, Duo-Lok™ quick-connect buckles, Revolver™ vertical torso adjuster, non-slip hybrid comfort padding, suspension trauma straps, impact indicator, REPEL™ technology webbing.

Note: Ideal for women



Product Code	Description
613S2016	Small
613M2016	Medium
613L2016	Large
613XL2016	Extra Large

ExoFit NEX™ Tower Workers Harness

Ideal for the professional performing pole work, rigging and work positioning.

Front, rear and side Tech-Lite™ aluminium D-rings, Duo-Lok™ quick-connect buckles, Revolver™ vertical torso adjusters, wide padded lower back/hip pad, work positioning/suspension seat with tanged pole D-rings (can be secured out of the way for unhindered climbing), non-slip hybrid comfort padding, suspension trauma straps, impact indicator, REPEL™ technology webbing.



Product Code	Description
653S4016	Small
653M4016	Medium
653L4016	Large
653XL4016	Extra Large

ExoFit NEX™ Suspension Harness with Chest Ascender

Ideal for the professional ascending working lines.

Front, rear, side and abdominal Tech-Lite™ aluminium D-rings, integral chest ascender, Duo-Lok™ quick-connect buckles, padded lower back/hip pad, gear loops, non-slip hybrid comfort padding, REPEL™ technology webbing.



Product Code	Description
783S4010	Small
783M4010	Medium
783L4010	Large
783XL4010	Extra Large

B – Body Harnesses



ExoFit NEX™ Flotation Harness

Ideal for the professional requiring both fall and buoyancy protection in open or closed waters.

275N integral personal flotation device, rear stainless steel D-ring, front fall arrest loops, stainless steel quick-connect buckles, non-slip hybrid comfort padding, suspension trauma straps, impact indicator, REPEL™ technology webbing (also available with 300 MED/SOLAS personal flotation device).



Product Code	Description
603S1034	Small
603M1034	Medium
603L1034	Large
603XL1034	Extra Large

ExoFit NEX™ Climbing Harness

Ideal for the professional performing rescue and emergency services, industrial rope access, abseiling and tower work.

Front, rear, side and abdominal Tech-Lite™ aluminium D-rings, Duo-Lok™ quick-connect buckles, padded lower back/hip pad, tool & gear loops, non-slip hybrid comfort padding, REPEL™ technology webbing.



Product Code	Description
683S4016	Small
683M4016	Medium
683L4016	Large
683XL4016	Extra Large

ExoFit NEX™ Suspension Harness

Ideal for the professional performing rescue and emergency services, industrial rope access, abseiling and tower work.

Front, rear, side and abdominal Tech-Lite™ aluminium D-rings, Duo-Lok™ quick-connect buckles, padded lower back/hip pad, gear loops, non-slip hybrid comfort padding, REPEL™ technology webbing.



Product Code	Description
783S4016	Small
783M4016	Medium
783L4016	Large
783XL4016	Extra Large

B – Body Harnesses



ExoFit NEX™ Sit Harness

Ideal for the professional performing rescue and emergency services, industrial rope access and abseiling work.

Side Tech-Lite™ aluminium D-rings, Duo-Lok™ quick-connect buckles, front belay loops, padded lower back/hip pad, tool & gear loops, non-slip hybrid comfort padding, REPEL™ technology webbing



Product Code	Description
673S4002	Small
673M4002	Medium
673L4002	Large
673XL4002	Extra Large

ExoFit NEX™ Derrickmans Harness

Ideal for oil industry personnel when working on the derrick/monkey board.

Front, rear (with extension), side and rear lower back Tech-Lite™ aluminium D-rings, Duo-Lok™ quick-connect buckles, Revolver™ vertical torso adjusters, non-slip hybrid comfort padding, seat sling with positioning/ suspension D-rings, suspension trauma straps, impact indicator, REPEL™ technology webbing (optional: monkey board belt – 1000570, high performance suspension seat – 1150011).



Product Code	Description
693S4017	Small
693M4017	Medium
693L4017	Large
693XL4017	Extra Large

ExoFit NEX™ Mines Rescue Harness

Ideal for use by mining industry personnel for use with battery packs and self rescuers.

Front and abdominal Tech-Lite™ aluminium D-rings, side aluminium karabiners, integral chest ascender, Duo-Lok™ quick-connect buckles, sewn-in wide padded miners belt incorporating battery and self rescue straps, gear loops, non-slip hybrid comfort padding, REPEL™ technology webbing.



Product Code	Description
783S4035	Small
783M4035	Medium
783L4035	Large
783XL4035	Extra Large

B – Body Harnesses



DBI-SALA DELTA™ II Harnesses

DELTA™ II Rigger's Harness

Ideal for use in rigging, confined space, ladder access and general height safety.

Large rear fall arrest rated stand-up D-ring, front fall arrest rated D-ring, confined space/retrieval attachment points, quick-connect buckles, corrosion resistant hardware, fully adjustable, REPEL™ technology webbing.



Product Code	Description
803S0018	Small
803M0018	Medium
803L0018	Large
803XL0018	Extra Large

DELTA™ II All Purpose Harness

Ideal for use in multi purpose access situations including confined space entry, rigging, ladder access work and work positioning at height.

Large rear fall arrest rated stand-up D-ring, front fall arrest rated D-ring, confined space/retrieval attachment points, waist belt with side D-rings, quick-connect buckles, corrosion resistant hardware, fully adjustable, REPEL™ technology webbing.



Product Code	Description
823S0018	Small
823M0018	Medium
823L0018	Large
823XL0018	Extra Large

DELTA™ II Miner's Harness

Ideal for use by mining industry personnel for use with battery packs and self rescuers.

Large rear fall arrest rated stand-up D-ring, Front fall arrest rated D-ring, confined space/retrieval attachment points, integral miners belt with battery and self rescue straps, reflective tape, suspension trauma straps, quick-connect buckles, corrosion resistant hardware, fully adjustable, REPEL™ technology webbing.



Product Code	Description
823S0035	Small
823M0035	Medium
823L0035	Large
823XL0035	Extra Large

B – Body Harnesses



DELTA™ II Cross-Over Harness

Ideal for use in roof construction, maintenance and ladder access work.

Large rear fall arrest rated stand-up D-ring, front fall arrest D-ring, quick-connect buckles, corrosion resistant hardware, fully adjustable, REPEL™ technology webbing.

Note: Ideal for women.



Product Code	Description
813S0016	Small
813M0016	Medium
813L0016	Large
813XL0016	Extra Large

DELTA™ II Tower Worker's Harness

Ideal for use by telecommunications and power industry personnel when working on towers and poles.

Large rear fall arrest rated stand-up D-ring, frontal fall arrest/belay loops, confined space/retrieval attachment points, padded waist belt with side D-rings, pole/restraint D-rings, quick-connect buckles, corrosion resistant hardware, fully adjustable, REPEL™ technology webbing.



Product Code	Description
853S0018	Small
853M0018	Medium
853L0018	Large
853XL0018	Extra Large

DELTA™ II Live Line Harness

(Resistant to electrical conductivity)*

Ideal for use when working on high and low voltage live lines from an EWP vehicle.

Rear fall arrest rated webbing loop with integrated dorsal extension, frontal fall arrest/belay loops, confined space loops, leather insulators, no metal hardware above the waist, quick-connect buckles, corrosion resistant hardware, fully adjustable, REPEL™ technology webbing.

*No metal hardware above the waist



Product Code	Description
803S0009	Small
803M0009	Medium
803L0009	Large
803XL0009	Extra Large

B – Body Harnesses

DELTA™ II Nomex®/ Kevlar® Harness*

Ideal for use in 'Hot Work' and arc flash environments.

Rear stand-up D-ring, front fall arrest rated loops, confined space loops, Nomex®/Kevlar® webbing, dielectric hardware.

*Arc flash, flame, heat and cut resistant



Product Code	Description
320S2066NK	Small
320M2066NK	Medium
320L2066NK	Large
320XL2066NK	Extra Large

DELTA™ II BA Harness

Ideal for Use with large cylinder breathing apparatus equipment.

Dorsal extension with large fall arrest rated D-ring, front fall arrest rated D-ring, confined space/retrieval attachment points, quick-connect buckles, waist belt with side D-rings, stainless steel hardware, wide padded lower back/hip pad, shoulders, back and waist protection pad with tank attachment straps, fully adjustable, REPEL™ technology webbing.



For illustrative purposes only. Breathing Apparatus equipment not included.

Product Code	Description
823S1051	Small
823M1051	Medium
823L1051	Large
823XL1051	Extra Large

DELTA™ II BA Rescue/Escape Harness

Ideal for Use with rescue/escape breathing apparatus equipment.

Large rear fall arrest rated D-ring, front fall arrest rated D-ring, confined space/retrieval attachment points, quick-connect buckles, stainless steel hardware, Air line attachment straps, rear BA pigtail connection strap, fully adjustable, REPEL™ technology webbing.

Note: Hip mounted escape cylinder bag to be supplied by customer for attachment to harness



For illustrative purposes only. Breathing Apparatus equipment not included.

Product Code	Description
823S1050	Small
823M1050	Medium
823L1050	Large
823XL1050	Extra Large

B – Body Harnesses



DELTA™ II Suspension Harness

Ideal for rescue and emergency services, industrial rope access, abseiling and tower work.

Front, rear, side and abdominal D-rings, quick adjust buckles, padded lower back/hip pad, tool 'O' rings, fully adjustable, REPEL™ technology webbing.

Note: Also conforms to AS/NZS 4488.1 & 2 Twin Rope Access Standard



Product Code	Description
883S4016	Small
883M4016	Medium
883L4016	Large
883XL4016	Extra Large

DBI-SALA Fall Protection Kits

Suited for specific worker applications, our kits include all the necessary components of the ABC of fall protection to ensure worker safety.



1900-0004



1900-0005

Product Code	Description
1900-0002	Cherry Picker's Kit , includes: Delta™ 321M-0018 Rigger's Harness with adjustable integral EZ Stop® lanyard, 1900-0000 Equipment/Kit Bag
1900-0004	Construction Worker's Kit , includes: Delta™ 380M-0018 All Purpose Harness, 3101000 2.4m Talon® SRL, Z90203636 EZ Stop® 2.0m Lanyard, E849-015 Tie-Off Adaptor, 1900-0000 Equipment / Kit Bag
1900-0005	Professional Roof Worker's Kit , includes: Delta™ 360M-0016 Roof Workers Harness, Z90103636 EZ Stop® 1.0m Lanyard, P6711-015-36-58 15m Rope and Rope Grab, R-105-S Screw Gate Karabiner, E849-015 Tie-Off Adaptor, 1900-0000 Equipment/Kit Bag
1900-0027	Professional Roof Worker's Kit without harness , includes: Z90103636 EZ Stop® 1.0m Lanyard, P6711-015-36-58 15m Rope and Rope Grab, R-105-S Screw Gate Karabiner, E849-015 Tie-Off Adaptor, 1900-0000 Equipment/Kit Bag
1900-0039	Live Line Kit , includes: Delta™ 305M-0019 Live Line Harness, Z95170606RPX EZ Stop® Live Line 1.7m Lanyard, Equipment/Kit Bag
1900-0047	Stock Picker's Kit , includes: 320M-0019 Delta™ Riggers Harness with dorsal extension, 3101009 Talon® SRL with stock pickers cab mount bracket and swivel snap hook, 1900-0000 Equipment/Kit Bag
1900324M	Delta™ Mine Utility Kit, Medium , includes: 324M-0019 Delta™ Riggers Utility Harness with dorsal extension, E404M Mine Utility Belt, 1900-0000 Equipment/Kit Bag. Also available in small, large and extra large sizes
1900404M	Exofit Nex™ Mine Utility Kit, Medium , includes: 603M1021 ExoFit NEX™ Riggers Utility Harness with dorsal extension, E404M Mine Utility Belt, 1900-0000 Equipment/Kit Bag. Also available in small, large and extra large sizes)



1900404M

B – Body Harnesses

DBI-SALA Miners Belts



Product Code	Description
E100M-0051	Medium, with rear D-ring, battery pack and self rescue straps with velcro, reflective tape on rear
E100M-0179	Medium, with rear D-ring, fixed braces, battery pack and self rescue straps with velcro, reflective tape on front and rear
E100M-0837	Medium, with 2 front D-rings, detachable braces, battery pack and self rescue straps, reflective tape on front and rear
E112M-0033	Medium, with detachable battery pack and self rescue straps, 2 front D-rings, reflective tape along entire length of belt
E404M	Mine Utility Belt, Medium, with wide cushioned body pad, leather tongue buckle adjustment/closure, PVC coated battery and self rescuer attachment strap, fluorescent webbing and harness locating attachment/detachment straps. Specially designed to fit and be used in conjunction with the ExoFit NEX™ & Delta™ Riggers Utility Harness



E100M-0051

Note: Miners belts are available in small, medium, large and extra Large.
 Mine Utility Belt available in small, medium and large only.



E100M-0179



E112M-0033



E100M-0837



E404M

B – Body Harnesses

B-Safe Harness Selection Guide



Product Code	Front & rear fall arrest points	Suitable for working in fall restraint technique	Can be used with fall arrest energy absorbing lanyard	Can be used with a fall arrest inertia reel	Can be used for work positioning	Confined space retrieval/ rescue loops	Certified to AS/NZS 1891.1.2007	Restrained fall & pole strap side D's at waist level
BH01112	✓	✓	✓	✓	✓		✓	✓
BH01120	✓	✓	✓	✓	✓		✓	
BH01121	✓	✓	✓	✓	✓		✓	✓
BH01124	✓	✓	✓	✓	✓		✓	
BH01132	✓	✓	✓	✓	✓		✓	
BH01151	✓	✓	✓	✓	✓		✓	
BH01152	✓	✓	✓	✓	✓		✓	
BH02020	✓	✓	✓	✓	✓	✓	✓	
BH02030	✓	✓	✓	✓	✓	✓	✓	✓
BH02030-PAD	✓	✓	✓	✓	✓	✓	✓	✓
BH02051	✓	✓	✓	✓	✓	✓	✓	
BH04050	✓	✓	✓	✓	✓	✓	✓	✓
BH04055	✓	✓	✓	✓	✓	✓	✓	✓
BH05200	✓	✓	✓	✓	✓	✓	✓	✓



B – Body Harnesses

Harness Fitting Instructions



Before using the B-Safe harness, users should do a pre-inspection the harness webbing, metal fittings connection points, and labels for damage. Refer to instruction booklet and if in any doubt you should contact your supervisor, supplier or B-Safe for advice.

- 1 Hold the harness by the rear dorsal connection Dee ring and gently shake the harness to untangle the straps. Ensure the leg straps are free and not buckled up. Ensure that all straps are fully extended. Whilst holding the harness by the dorsal dee, carry out a pre use inspection of the components, webbing, stitching and buckles. Check labelling, identify the withdrawal from service date has not passed.
- 2 Hold the harness with the Dorsal Dee facing away from you, place the shoulder straps of the harness over your hands (as shown) and hold the harness open.

- 3 Rotate harness and insert elbow into arm loop and then place arm through the loop, release shoulder strap and place other arm through the other shoulder loop and let harness fall onto the shoulders. Ensure that the harness is fitted correctly without any webbing twists over the shoulders.

- 4 Buckle all straps prior to adjusting the fit. Locate chest strap and pass the smaller buckle plate through the other chest strap buckle. (As shown in the "How to assemble buckles" diagrams). Locate leg straps and ensure that the left leg strap is connected to the left hip buckle and the right leg strap is connected to the right hip buckle. Ensure the straps are not twisted and the loose webbing end is always on the outside, away from the body. Hold buckle and pull webbing to tighten straps to a firm and comfortable fit and slide keepers along the leg strap webbing to hold free webbing.

- 5 Adjust shoulder straps first to ensure that the rear dorsal dee is located between the shoulder blades in the centre of the back. Then adjust chest and leg straps to a firm fit, and slide webbing keepers along to hold free webbing in place.

- 6 When using the front attachment points, both loops must be connected as per AS/NZS 1891.1 - 2007



How to assemble buckles

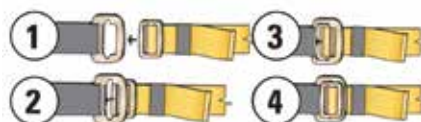

B – Body Harnesses

Harness BH01120

Features

- › Lightweight and comfortable.
- › Rear attachment point.
- › Front attachment points.
- › Fully adjustable leg, shoulder and chest straps.

Applications and Usage

- › **Fall Arrest** – Use in conjunction with an energy absorbing lanyard or inertia reel device attached to the front loops or rear D-ring.
- › **Restraint Technique** – Use in conjunction with an energy absorbing lanyard to rear D-ring or front loops to limit access to fall situations.
- › **Recovery & Rescue** – Using both front loops connected together.



Harness BH01121

Features

- › Lightweight and comfortable.
- › Front & rear attachment points.
- › Side 'D-rings' for work positioning.
- › Fully adjustable leg, shoulder, chest and waist straps.

- › **Restraint Technique** – Use in conjunction with an energy absorbing lanyard to rear D-ring or front loops to limit access to fall situations.
- › **Work Positioning** – Side D-rings for use with a Pole Strap.
- › **Recovery & Rescue** – Using both front loops connected together.

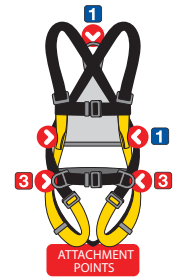

Harness BH01124

Features

- › Lightweight and comfortable.
- › Rear attachment point with extension strap.
- › Front attachment loops.
- › Fully adjustable leg, shoulder and chest straps.

Applications and Usage

- › **Fall Arrest** – Use in conjunction with an energy absorbing lanyard or inertia reel device attached to the front loops, rear D-ring or rear extension.
- › **Restraint Technique** – Use in conjunction with energy absorbing lanyard to rear D-ring, rear extension or front loops to limit access to fall situations.
- › **Recovery & Rescue** – Using both front loops connected together.



B – Body Harnesses

Harness BH01132

Features

- › Lightweight and comfortable.
- › Comes complete with 2m wire energy absorbing lanyard permanently attached to the rear D-ring.
- › Fully adjustable leg, shoulder and chest straps.

Applications and Usage

- › **Fall Arrest** – Using the integrated energy absorbing lanyard on the rear D-ring, an inertia reel device attached to the rear D-ring or front loops or a separate lanyard attached to the front loop.
- › **Restraint Technique** – Use in conjunction with an energy absorbing lanyard to rear D-ring or front loops to limit access to fall situations.
- › **Recovery & Rescue** – Using both front loops connected together.



B-Safe

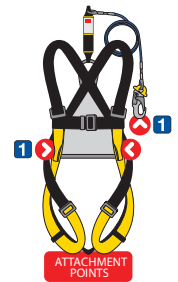

Harness BH01112

Features

- › Lightweight general purpose harness
- › Comes complete with 2m energy absorbing lanyard permanently attached to the rear D-ring.
- › Fully adjustable leg, shoulder, chest and waist straps.

Applications and Usage

- › **Fall Arrest** – Use in conjunction with an energy absorbing lanyard or inertia reel device attached to the front loops, rear D-ring.
- › **Restraint Technique** – Using the integrated energy absorbing lanyard on the rear D-ring or a separate lanyard attached to the front loops to limit access to fall situations.
- › **Recovery & Rescue** – Using both front loops connected together.
- › **Work Positioning** – Using side D-rings connected with a Pole Strap.



B – Body Harnesses

Harness BH01151

Features

- › Lightweight and comfortable.
- › Comes complete with 2m web energy absorbing lanyard permanently attached to the rear D-ring.
- › Front attachment loops.
- › Fully adjustable leg, shoulder and chest straps.

Applications and Usage

- › **Fall Arrest** – Using the integrated energy absorbing lanyard on the rear D-ring, an inertia reel device attached to the rear D-ring or front loops or a separate lanyard attached to the front loops .
- › **Restraint Technique** – Use in conjunction with an energy absorbing lanyard to rear D-ring or front loops to limit access to fall situations.
- › **Recovery & Rescue** – Using both front loops connected together.

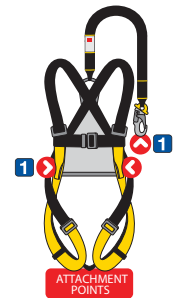

Harness BH02020

Features

- › Lightweight and comfortable.
- › Rear attachment D-ring with extension strap and load indicator.
- › Front & rear fall arrest attachment points.
- › Confined space recovery loops on tops of shoulder.
- › Fully adjustable leg, shoulder and chest straps.

Applications and Usage

- › **Fall Arrest** – Use in conjunction with an energy absorbing lanyard or inertia reel device attached to the front loops, rear extension or rear D-ring.
- › **Restraint Technique** – Use in conjunction with an energy absorbing lanyard to rear D-ring rear extension or front loops to limit access to fall situations.
- › **Recovery & Rescue** – Using both front loops connected together.
- › **Confined Space** – Rescue & recovery.



B – Body Harnesses

Harness BH02030

Features

- › Lightweight and comfortable.
- › Rear attachment D-ring with extension strap and load indicator.
- › Front fall arrest loops.
- › Confined space recovery loops on tops of shoulder.
- › Side D-rings for work positioning.
- › Fully adjustable leg, shoulder, chest and waist straps.

Applications and Usage

- › **Fall Arrest** – Use in conjunction with an energy absorbing lanyard or inertia reel device attached to the front loops, rear extension or D-ring.
- › **Restraint Technique** – Use in conjunction with an energy absorbing lanyard to rear D-ring, rear extension or front loops to limit access to fall situations.
- › **Work Positioning** – via side D-rings using a pole strap.
- › **Confined Space** – Rescue & recovery.
- › **Recovery & Rescue** – Using both front loops connected together.



B-Safe

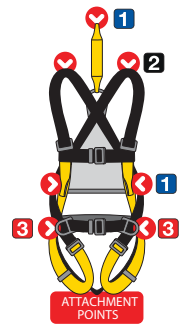

Harness BH02030PAD

Features

- › Lightweight and comfortable.
- › Rear attachment D-ring with extension strap and load indicator.
- › Confined space recovery loops on tops of shoulder.
- › Side D-rings for work positioning.
- › Large back pad for user comfort and support.
- › Fully adjustable leg, shoulder and chest straps.

Applications and Usage

- › **Fall Arrest** – Use in conjunction with an energy absorbing lanyard or inertia reel device attached to the front loops, rear extension or rear D-ring.
- › **Restraint Technique** – Use in conjunction with an energy absorbing lanyard to rear D-ring, rear extension or front loops to limit access to fall situations.
- › **Work Positioning** – via side D-rings using a pole strap.
- › **Confined Space** – Rescue & recovery.
- › **Recovery & Rescue** – Using both front loops connected together.



B – Body Harnesses

Harness BH04055

Features

- › Built in padded back support.
- › Built in bum strap.
- › Rear D-ring rear connection on extension strap.
- › Side D-rings for attachment devices.
- › Fully adjustable leg, shoulder, waist and chest straps.

Applications and Usage

- › **Fall Arrest** – Use in conjunction with an energy absorbing lanyard or inertia reel device attached to the front loops, rear D-ring or rear extension.
- › **Restraint Technique** – Use in conjunction with an energy absorbing lanyard to rear D-ring or front loops to limit access to fall situations.
- › **Work Positioning** – via side D-rings using a pole strap.
- › **Confined Space** – Rescue & recovery.
- › **Recovery & Rescue** – Using both front loops connected together.



Harness BH04050

Features

- › Built in padded back support.
- › 2.5m pole strap.
- › Built in bum strap.
- › Rear D-ring rear connection on extension strap.
- › Side D-rings for attachment devices.
- › Fully adjustable leg, shoulder, waist and chest straps

Applications and Usage

- › **Fall Arrest** – Use in conjunction with an energy absorbing lanyard or inertia reel device attached to the front loops, rear extension or rear D-ring.
- › **Restraint Technique** – Use in conjunction with an energy absorbing lanyard to rear D-ring, rear extension or front loops to limit access to fall situations.
- › **Work Positioning** – via side D-rings using a pole strap.
- › **Confined Space** – Rescue & recovery.
- › **Recovery & Rescue** – Using both front loops connected together.



B – Body Harnesses

Harness BH05200

Features

- > Built in padded back support.
- > Padded thigh straps.
- > Tool loops.
- > Fall arrest rated attachment D-ring incorporated onto long extension strap for ease of connection.
- > Side D-rings. Front fall arrest D-rings.
- > Confined space recovery loops.
- > Fully adjustable thigh, shoulder, and waist straps.

Applications and Usage

- > **Abseiling** – Use the front fall arrest D-rings.
- > **Fall Arrest** – Use in conjunction with shock absorbing lanyard or inertia reel device attached to the front D-rings or rear extension.
- > **Restraint Technique** – Use in conjunction with energy absorbing lanyard to front or rear attachment points.
- > **Work Positioning** – Use in conjunction with pole strap or adjustable lanyard attached to both side D-rings.
- > **Confined Space** – Work in conjunction with shoulder loops and spreader bar.

Available with Stainless Steel fittings on request.

Also available in fire proof, cut resistant Nomex/Kevlar webbing



C – Connectors

DBI-SALA Karabiners

Product Code	Description	Gate	Mining
	Screw Gate		
R-105-S	18mm gate opening		
R-105-S-CE	18mm gate opening with captive eye		
R-517	26mm gate opening with captive eye*	HD 16kN	
	Autolock		
R-308	14mm gate opening with captive eye		
R-523	20mm gate opening with captive eye*	HD 16kN	
R-024	25mm gate opening		
R-108	54mm gate opening with captive eye*	HD 16kN	
	Triple Action Lock with Captive Eye		
R-113	19mm gate opening*	HD 16kN	✓
R-119	20mm gate opening (stainless steel)*	HD 16kN	✓

*These karabiners feature 16kN rated side gates.



B-Safe Karabiners and Hooks

Product Code	Description	Min breaking force (kN)
BSK0002TC	Steel Triple-lock Karabiner c/w retaining pin	35
BSM0007	Double Action Hook with safety guard to prevent accidental opening of second action. 19mm gate opening	23
BSM0007A	Alloy Double Action Hook with safety guard to prevent accidental opening of second action. 20mm gate opening	22.5
BSK0001	Steel Screw Gate Karabiner. 16mm gate opening	23
BSK0011	Alloy Screw Gate Karabiner. 22mm gate opening	30
BSK0005	Steel Screw Gate Karabiner. c/w retaining pin. 26mm gate opening	42
BSK0012	Alloy Screw Gate Karabiner. 23mm gate opening	27
BSK0006	Steel Triplelock Karabiner. Also available in stainless steel. 27mm gate opening	50
BSK0013	Alloy Triplelock Karabiner. 27mm gate opening	30
BSM0008	Steel Double Action Scaffold Hook. 55mm gate opening	23
BSM0008A	Alloy Double Action Scaffold Hook. 60mm gate opening	22.2
BSK0015	Steel Twist Lock Scaffold Hook Karabiner. c/w Retaining Pin. 56mm gate opening	22
BFK08	Manulink 140mm	22.2



Note: Some karabiners and hooks shown on this page are manufactured to be permanently attached to lanyards and other height safety equipment and may not be sold separately. Please contact your local Robertsons branch for further information.

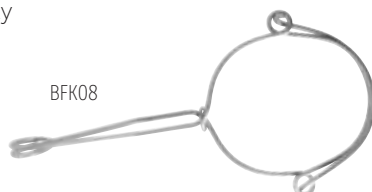

C – Connectors

DBI-SALA Rope Grabs & Lifelines



Product Code	Description
P6711-015-36-58	Lifeline with Integral Manual Rope Grab (horizontal / angle work) 15m system, 11mm kernmantle rope, rope grab and H205 hook Also available: other length systems
AC202/02AU	Cobra Automatic Rope Grab (vertical work) Includes karabiner and integral shock pack, for use on 12-14mm 3 strand rope or 11-13mm kernmantle rope



P6711-015-36-58



AC202/02AU

B-Safe Vertical Safety Lifelines

B-Safe Vertical Safety Lifelines can be set up on a temporary or permanent basis. The safety line should be used under tension between the anchor and the rope grab device so that the fall distance is limited to the operational speed of the rope grab.

Note: It is important that the top attachment point is suitable for the application and rated accordingly.



Rope only – double action hook one end	Rope with double action hook one end and manual rope grab	Rope diameter and length
BS010105	BS010105A	11mm Kernmantle – 5m
BS010110	BS010110A	11mm Kernmantle – 10m
BS010115	BS010115A	11mm Kernmantle – 15m
BS010120	BS010120A	11mm Kernmantle – 20m
BS010125	BS010125A	11mm Kernmantle – 25m
BS010130	BS010130A	11mm Kernmantle – 30m
BS010140	BS010140A	11mm Kernmantle – 40m
BS010150	BS010150A	11mm Kernmantle – 50m
BS030120	BS030120A	16mm Polyester – 20m



BSM0012 manual rope grab 11mm rope



BSM0016 Auto Openable with parking features rope grab 16mm rope



BSM0016B manual rope grab 16mm rope



BSM500A Rocker Auto openable 11mm rope



C – Connectors



Vertical Systems

DBI-SALA Lad-Saf® System

Features

- › Designed for restrained fall arrest
- › Unique Lad-Saf® sleeve prevents falls by locking onto the cable. It is easily attached or removed anywhere along the cable using a deliberate double action locking mechanism and automatically follows as you climb or descend.
- › Dual function top bracket features an elastomeric impact attenuator and a unique cable gripping device.
- › Non-metallic cable guides reduce cable wear, permitting you to ascend or descend unhindered.
- › Easy tensioning bottom bracket features a simple and quick to use adjusting mechanism whilst the washer system indicates that correct tension has been reached.
- › Replaceable components
- › Systems available in either bolt on or weld on styles, constructed from either galvanised mild steel or stainless steel.

- › Meets or exceeds all applicable industry standards.

Applications

- › Ideal for ascending and descending from all vertical applications including permanent ladders, power poles, electrical towers and chimneys.

Specifications

- › Complies with AS/NZS 1891.3:1997.

Model #	Description
	Lad-Saf® Kits
LS-B	Bolt on system, galvanised
LS-W	Weld on system, galvanised Also available: stainless steel models
	Lad-Saf® Sleeves
6116540	Lad-Saf® sleeve with karabiner
6116507	Lad-Saf® sleeve with karabiner and shock pack



Lad-Saf® System



6116507

DBI-SALA Pole Straps

Product Code	Description
E601 Series	Pole Strap with H205 Hooks & H086 Easy Adjuster Available in 2m, 2.5m, 3m
E613 Series	Pole strap with Light Weight Alloy Hooks & DBI-SALA Friction Adjuster Available in 2m, 2.5m, 3m
E850 Series	Pole Strap Wire Core with Rope Grab & H205 Hook Available in 3m, 4m
E613 RPY Series	REPEL™ Pole Strap range 2.5m, 3.0m, 3.5m

Note: All pole straps are fitted with latch protection devices.



E601-020



E850-3.0M



E613RPY0250909



E613-B-020-56-56



Latch Protection Devices (LPD) are standard on all DBI-SALA Pole Straps

C – Connectors

B-Safe Pole Straps

The pole strap is designed to fully restrain the user so that there is no chance of any free fall. It is used by going around the pole over a cross brace and attaching to both sides of the harness at the waist belt. This then permits the user to work in a safe and retained location.



BP02112 2m Pole Strap



Product Code	Description
BP02111.5	1.5m Pole strap, wear sleeve, double action hooks, adjustable
BP02112	2m Pole strap, wear sleeve, double action hooks, adjustable
BP02112.5	2.5m Pole strap, wear sleeve, double action hooks, adjustable
BP02113	3m Pole strap, wear sleeve, double action hooks, adjustable
BP02113.5	3.5m Pole strap, wear sleeve, double action hooks, adjustable

*Other lengths available for special applications.



Energy (Shock) Absorbing Lanyards

DBI-SALA EZ-STOP™ Shock Absorbing Lanyards Range



Product Code	Description		Mining
Kermantle Rope			
Z20203636	Single tail 2.0m overall length	HD 160kg	
Z96204545	Twin tail 2.0m overall length	HD 160kg	✓
ZP67110204560X	Adjustable, single tail 2.0m overall length Also available: Double Tail	HD 160kg	✓
Webbing			
Z90203636	Single tail 2.0m overall length	HD 160kg	
Z90203634E	Single tail, elastic 2.0m overall length	HD 160kg	
Z60203636	Double tail, 2.0m overall length	HD 160kg	
Z60203634E	Double tail, elastic 2.0m overall length	HD 160kg	
Z62153645	Double tail, Tie back 1.5m overall length	HD 160kg	✓
Z51200934	Single tail, Adjustable 2.0m overall length	HD 160kg	
Wire Cable			
Z70203636	PVC coated cable, single tail 2.0m overall length	HD 160kg	
Z40203634	PVC coated cable, twin tail 2.0m overall length	HD 160kg	



C – Connectors



DBI-SALA FORCE2™ Shock Absorbing Lanyards Range

The next revolution in lanyard technology. The new and improved FORCE2™ shock absorbing lanyard range now even lighter, stronger and more durable than ever. Featuring the smallest shock absorber in the world, 66% smaller and 40% lighter, with an expanded range of connector combinations that are the lightest and strongest on the market.

Features

- > Weight reduced triple action karabiners, snap hooks and scaffold hooks
- > Lightest, strongest, smallest shock absorber in the world that includes Hi-10™ high tenacity energy management material
- > REPEL™ Technology webbing, water repellent to reduce the attraction of mold and dirt and up to 5 times more abrasion resistance than standard webbing

- > Cut resistant rope for use in areas where there is a high risk of abrasion or cutting of the lanyard tails
- > PVC coated wire cable lanyards for use in harsh environments
- > WrapBax tieback model for tie-off applications
- > Protected labels for durability and longevity – includes DBI-SALA's i-SAFE™ identification tag
- > High visibility reflective material keeps you safe in low light conditions

Product Code	Description	Rating	Gate	Mining
Force 2™ Series				
Z11200909	Single tail, Adjustable, 2.0m overall length	HD160kg	HD16kN	
Z10202572WB	Single tail, 2.0m overall length with WrapBax™ snap hook on tail	HD160kg	HD16kN	
Z11204545	Single tail, adjustable, 2.0m overall length	HD160kg	HD16kN	✓
Z12202519E	Double tail, Elastic, 2.0m overall length	HD160kg	HD16kN	
Z10200909	Single tail, 2.0m overall length	HD160kg	HD16kN	
Z10202519E	Single tail, elastic, 2.0m overall length	HD160kg	HD16kN	
Z10204545WR	Single tail, PVC coated wire cable	HD160kg	HD16kN	✓
Z13206129R	Double tail, adjustable, kernmantle rope, 2.0m overall length with triple action scaffold hooks on adjusters	HD160kg	HD16kN	✓
Z11206159CR	Single tail, adjustable, cut resistant kernmantle rope, 2.0m overall length with triple action karabiners	HD160kg	HD16kN	✓



Z11200909

Z10202572WB



Z11204545

Z12202519E

If a dorsal extension is part of your harness the maximum lanyard assembly permitted is 1.7m or less.

All DBI-SALA shock absorbing lanyards are available in either single or double tail configurations constructed from webbing, wire or rope in a variety of styles (elasticated, non-elasticated, adjustable and tie-back), and are available with a wide combination of hook & karabiner terminations, including triple action connectors, suitable for all industry applications and demands.



Z10200909



Z10202519E



Z10204545WR



Z13206129R



Z11206159CR



Additional latch protection on selected models



All double tail lanyards are supplied with E839 lanyard stowage points.

C – Connectors



DBI-SALA Specialty Lanyards

Product Code	Description	Rating	Gate
Z60200919EW	Wind Energy Rescue Lanyard Incorporating rescue D-rings and heavy duty wear pads, this lanyard has been specifically designed and developed to meet the demands of the wind energy industry.	HD160kg	HD16kN
Z95170945RP	Live Line Lanyard Specifically designed for use when working on high and low voltage lines from an EWP vehicle to resist electrical conductivity.	HD160kg	HD16kN
Z90200909NKE	Nomex®/Kevlar® Lanyards High temperature heavy duty lanyards ideal if you are welding, cutting or grinding, or in a potentially explosive or high-voltage electrical environment. Available in single and twin tail models (elasticated or flat webbing) with a range of connectors including triple action karabiners.	HD160kg	HD16kN
Z91200909	Resist Lanyard Coated with an extruded polyurethane coating to provide superior protection against grease, oil, paint, dirt and grime. Ideal for use in the petrochemical and painting industries.	HD160kg	HD16kN



Z60200919EW



Z95170945RP



Z90200909NKE



Z91200909



C – Connectors



Self Retracting Lifelines (SRL's) and Accessories

Nano-Lok™ Self Retracting Lifelines

Compact, versatile and safe, the Nano-Lok™ Self Retracting Lifelines are ergonomically designed for ease-of-use. Virtually unnoticeable on the user's back they are ideal for direct connection to most harnesses.

- › Single or twin leg harness interface connector, cab mount or karabiner
- › 360 deg swivelling anchorage loop
- › Impact resistant housing
- › Automatic quick-activating arrestor
- › Impact indicator
- › Retractable lifeline

Product Code	Description	Impact indicator	Mining
3101330	Single lifeline with quick connector anchorage connection and steel snap hook available with stainless steel or swivel snap hook.		
3101331	Single lifeline with quick connector anchorage connection and aluminium scaffold hook. Also available with steel scaffold hook.		
3101336	Single lifeline with cab mount anchorage connection and steel swivel snap hook.	✓	
3101339	Single lifeline with steel triple action karabiners Also available with stainless steel triple action karabiners.		✓
3101342	Single lifeline with steel triple action karabiner connection and steel scaffold hook on lifeline Also available with stainless steel triple action karabiner and aluminium scaffold hook.		✓
3101343	Single lifeline with quick connector anchorage connection and steel triple action karabiner Also available with stainless steel triple action karabiner).		✓
3101345	Twin lifeline with quick connector anchorage connection and two aluminium scaffold hooks Also available with steel scaffold hook.		



3101330



3101331



3101336



3101339



3101342



3101343



3101345

C – Connectors

Talon™ SRL

A light, strong, safe and compact SRL with built-in connector for direct attachment to harness.

Product Code	Description	Impact indicator
3101000	2.4m webbing lifeline with quick connect mount handle and snap hook	
3101001	2.4m webbing lifeline with quick connect mount handle and swivel snap hook	✓
3101008	2.4m, with stock picker cab mount bracket and snap hook	
3101050	4.8m webbing lifeline, with swivel mount and snap hook	
3102010	1.8m webbing lifeline, twin tail, with scaffold hooks, comfort back pad and lanyard keepers	

Ultra-Lok™ SRL

Rugged, lightweight and superbly engineered. The professional's choice.

Product Code	Description	Impact indicator	Mining
3103107	3.4m webbing lifeline Also available: 6m		
3504430	10m galvanised cable lifeline Also available: 6m and 15m with either triple action Karabiners ideal for use in mining or swivel snap hook	✓	✓
	Ultra-Lok™ RSQ SRL		
3504555	15m stainless steel cable lifeline and swivel snap hook, dual mode SRL with rescue function (assisted rescue tool and First-Man-Up™ pole available separately if required)	✓	

Sealed BLOK™ SRL

Sealed design makes it ideal for working in even the harshest of environments.

Product Code	Description	Impact indicator	Mining
3400803	9m galvanised cable lifeline, with swivelling swivel snap hook and integral carrying handle Also available: Stainless steel cable model (3400804), stainless steel cable & hook model (3400805), galvanised cable with swivel triple action karabiner (3400806)	✓	✓
3400001	15m galvanised cable lifeline with swivel snap hook Also available with stainless steel cable (3400002)	✓	
3400012	15m galvanised cable lifeline with swivel triple action karabiner. Also available with stainless steel cable (3400013)	✓	✓
3400201	25m galvanised cable lifeline with swivel snap hook Also available with stainless steel cable (3400202)	✓	
3400212	25m galvanised cable lifeline with swivel triple action karabiner	✓	✓
3400401	39m galvanised cable lifeline with swivel snap hook Also available with stainless steel cable (3400402)	✓	
3400408	39m galvanised cable lifeline with swivel triple action karabiner.	✓	✓



Talon™ 3101001

Twin Talon™ 3102010

Ultra-Lok™ RSQ
3504555

Sealed BLOK™ 3400803

Ultra-Lok™ 3504430

Impact indicating snap hooks and karabiners provide a visual indication of fall arrest. Available on all DBI-SALA Ultra-Lok and Sealed cable lifeline SRL models, and select Talon and Nano-Lok webbing SRL's.



C – Connectors

Load Arrestors

Product Code	Description
3700300	12m of galvanised cable, 300kg load rating
3700400	8m of galvanised cable, 400kg load rating
3700501	5m of galvanised cable, 500kg load rating
3700801	4m of galvanised cable, 800kg load rating

SRL Accessories

Product Code	Description
Z6	Shock absorbing unit for leading edge work
8102102	Power Tagline System. Provides remote access to overhead mounted SRLs



3700300

8102102
SRL not included



Z6

Rebel™ Self Retracting Lifelines

Product Code	Description	Impact indicator	Mining
	Rebel™ Compact Self Retracting Lifelines complete with connecting karabiner on housing		
AD111ARA	3.3m, webbing		
AD111R-45-45	3.3m, webbing, triple action karabiners		✓
3506055	4.5m, cable (ideal for hot work)		
AD120BR	6m, webbing		
	Rebel™ Self Retracting Lifelines complete with connecting karabiner on housing and swiveling fall indicator snap hook		
3590520	6m, galvanised cable, thermoplastic housing	✓	
3590521	10m, galvanised cable, thermoplastic housing	✓	
3590570	15m, galvanised cable, thermoplastic housing	✓	
3590610	20m, galvanised cable, thermoplastic housing	✓	
3590690	30m, galvanised cable, thermoplastic housing Also available with stainless steel cable and aluminium housing. Mine spec models also available featuring triple action karabiners on housing and swivel impact indicating karabiners on lifeline.	✓	✓



3590570

AD111R-45-45



C – Connectors

Inertia Reels

IKAR robusto according to DIN EN 360

Housing material: Plastic or aluminium

Connective device: Webbing strap or galvanised steel wire rope

Sturdy, lightweight, low maintenance, self retracting inertia reel with either web straps or galvanised steel rope.

Lightweight plastic or aluminium housing with rotational hook.

Rotational hook prevents strap or wire rope from twisting within the housing.

IKAR fall protection systems feature a very high safety standard and worldwide proven technology.

Product Code	Connecting Device	Housing	Weight (kg)	Dimensions (mm)
H 12	12.00m Steel Rope	Aluminium	5.9	450 x 195 x 90
H 18	18.00m Steel Rope	Aluminium	9.5	550 x 240 x 100
H 24	24.00m Steel Rope	Aluminium	13.5	630 x 275 x 110
H 33	33.00m Steel Rope	Aluminium	18.0	640 x 320 x 120
H 42	42.00m Steel Rope	Aluminium	27.2	750 x 370 x 120
H 60	60.00m Steel Rope	Aluminium	38.0	780 x 390 x 150
H 7	7.00m Web	Plastic	2.9	370 x 195 x 100
H 14	12.00m Web	Plastic	4.4	550 x 240 x 100
HPS 5	5.00m Steel Rope	Plastic	2.9	430 x 150 x 91
HPS 6	6.00m Steel Rope	Plastic	30.0	430 x 150 x 91
HPS 12	12.00m Steel Rope	Plastic	4.6	470 x 190 x 114
HPS 18	18.00m Steel Rope	Plastic	6.7	540 x 225 x 96

Housing material: Plastic or aluminium

Connective device: Webbing strap or galvanised steel wire rope

Sturdy, low-maintenance height-safety device with webbing strap and galvanised steel rope, extra light plastic or aluminium housing and

rotational hook suspension. The rotational hook prevents the strap or rope from twisting.

Product Code	Connecting Device	Housing	Weight (kg)	Dimensions (mm)
HWB 2	2.00m Web	Aluminium	0.8	240 x 84 x 61
HWB 2,5	2.50m Web	Aluminium	1.2	315 x 123 x 75
HWB 3,5	3.50m Web	Aluminium	1.4	315 x 123 x 75
HWPB 3,5	3.50m Web	Plastic	1.2	326 x 104 x 78
HWPB 5,5	5.50m Web	Plastic	1.5	300 x 130 x 78
HWPB 7	7.00m Web	Plastic	1.8	300 x 145 x 80
HWPB 9	9.00 m Web	Plastic	2.3	335 x 167 x 88
HWPB 12	12.00m Web	Plastic	3.4	370 x 195 x 95
HWPB 15	15.00m Web	Plastic	4.8	400 x 195 x 95
HWS 4,5	4.50 m Steel Rope	Aluminium	2.7	400 x 130 x 78
HWS 6	6.00 m Steel Rope	Aluminium	3.0	400 x 145 x 80
HWS 9	9.00 m Steel Rope	Aluminium	3.7	455 x 160 x 85



C – Connectors

Load Arrestors

Product Code	Description
AD412/300	12m, galvanised cable, fall indicator, connecting karabiner on housing

SRL Accessories

Product Code	Description
AK150	Cable Recovery Unit (for Fall Arrestors) Tirvit (pulling and tensioning device)

Rope Grabs & Lifelines

Product Code	Description
AC202	Cobra Rope Grab - suits 12-14mm 3 strand polyester rope only
AC3000/10	10m Cabloc Vertical Lifeline Kit Also available: AC3000/20 (20m), AC3000/30 (30m)
AC400	Viper Rope Grab - suits 11-13mm kernmantle rope only
AC415AU	11mm kernmantle rope lifeline, karabiner, sewn eye splice & thimble and sewn end stop Also available: AC4420AU (20m) system, AC425AU (25m) system, AC430AU (30m) system
AC415MAU	11mm kernmantle rope lifeline, karabiner, backsplice and rope adjuster Also available: AC4420MAU (20m) system, AC430MAU (30m) system
AC415MBAU	11mm kernmantle rope lifeline with rope adjuster integral shock absorbing lanyard, karabiner and backsplice Also available: AC4420MBAU (20m) system, AC430MBAU (30m) system

Shock Absorbing Lanyards

Product Code	Description	Rating
	PROTECTA Shock Absorbing Lanyards	
AE529/3AU	Single tail, 2 x snap hooks, 2.0m	160kg
AE529/13AU	Single tail, 2 x snap hooks, 1.5m	160kg
AE529/25AU	Single tail, 1 x snap hook, 1 x karabiner, 1.0m	160kg
AE529E/3AU	Single tail, elasticated, 2 x snap hooks, 2.0m	160kg
AE529EY/5AU	Double tail, elasticated, 1 x snap hook, 2 x scaffold hooks, 2.0m	160kg
AE529Y/5AU	Double tail, 1 x snap hook, 2 x scaffold hooks, 2.0m	160kg
AE529ADJ/3AU	Single tail, adjustable, 2 x snap hooks, 0.75-2.0m	160kg
	FIRST™ Shock Absorbing Lanyard	
AE529FAU	Single Tail, 2.0m, with screw gate captive eye karabiners on both ends	160kg

Karabiners

Product Code	Description
R-105-S	Double action, screw gate, 18mm opening
AJ514	Double action, auto-lock, 16mm opening
AJ593	Double action, auto-lock, 50mm opening

Snap Hooks

Product Code	Description
07153	Double action, scaffold hook, 61mm opening
AJ592	Double action, anchor hook, 89mm opening

Pole Strap

Product Code	Description
AF725AU	2.5m with adjuster, snap hooks & protective sleeve



AD412/300



AC202



AC400



AC415MBAU



AE529EY/5AU



AE529ADJ/3AU



AE529FAU

All double tail lanyards are supplied with E839 Lanyard Stowage Points.



AJ514



AJ593



R-105-S



07153



AJ592



AF725AU

D – Descent, Rescue & Confined Spaces Equipment

Tripods

Product Code	Description
8000000	2.1m, aluminium, square legs
8000010	2.7m, aluminium, square legs
8003205	Snatch block, eye bolt pulley assembly
8003238	Leg mount pulley bracket

Note: Tripods come standard with integral pulley and one winch mounting bracket.



Emergency Retrieval Sealed SRLs

Product Code	Description	Impact indicator
3400854	9m, 5mm galvanised cable, with swivel impact indicator hook and integral carrying handle Also available with stainless steel cable or stainless steel cable & hook models	✓
3400101	15m, 5mm galvanised cable with swivel impact indicator hook Also available with stainless steel cable	✓
3400301	25m, 5mm galvanised cable with swivel impact indicator hook Also available with stainless steel cable	✓
3400501	39m, 5mm galvanised cable with swivel impact indicator hook Also available with stainless steel cable	✓
3401065	Mounting bracket to fit 3400101 to tripod leg	
3401123	Mounting bracket to fit 3400301 to tripod leg	
3401140	Mounting bracket to fit 3400501 to tripod leg	
3401255	Stabilising handle for retrieval SRL's	



Winches

Product Code	Description	Impact indicator
	Salalift® II Winch (lightweight)	
8102001	18m, 6mm galvanised cable	✓
8102009	27m, 5mm galvanised cable	✓
8102005	36m, 5mm galvanised cable Also available with stainless steel cable	✓
	Advanced Digital Winches	
8518560	18m, 5mm galvanised cable	
8518561	27m, 5mm galvanised cable	
8518582	58m, 5mm galvanised cable Also available with stainless steel cable and Technora rope	



Retrieval SRL Hitch Mount

Product Code	Description
8539999	Portable temporary anchorage points for DBI-SALA winches & SRL's, for use with vehicle hitch mounts



D – Descent, Rescue & Confined Spaces Equipment

Bosuns Chair/Spreader Bar

Product Code	Description
E822	0.6m bosuns chair (height from seat to D-ring)
E821	1.2m bosuns chair (height from seat to D-ring)
E823	1.2m bosuns chair with spreader bar
E522SB1	Spreader bar with karabiner connections



E822



E522SB1



Confined Space Equipment

Product Code	Description
	Confined Space Spreader Bar
ABSB0001AU	Retrieval straps with karabiner connections
	Tripod and Accessories
AM100	Tripod, 1.35m to 2.35m
AK0100	Tripod bag
AT052/1	Pulley with karabiner for use on tripod
AT0515	Fixing bracket for AD515
AT0525	Fixing bracket for AD525
	Retrieval Self Retracting Lifelines
AD515	Galvanised cable, 15m*
AD525	Galvanised cable, 25m*
	Rescue Winch
AT200/I20	Automatic locking system, 20m*

* When ordering a retrieval self retracting lifeline or rescue winch for use with the tripod, order the AT052/1 pulley and the appropriate fixing bracket. Alternatively contact Robertsons to obtain the part number.



ABSB0001AU

AM100



AD515



AT200/I20



AT052/1



AK0100

D – Descent, Rescue & Confined Spaces Equipment

Inertia Reels

Inertia Reels are a combination unit that operates as a normal inertia reel until such time as the raising and lowering capabilities are required. To engage the raising or lowering, the operator pulls out the release pin which then engages the manual mechanism.

The gearing of the device is 15:1 which means that minimal effort is required to raise or lower. Available with plastic housing in 15m lengths, also available in aluminium housing from 9.5m up to 60m.

Recovery Inertia Reels

Product Code	Housing	Length (m)
HRA15P	Plastic	15
HRA9.5	Aluminium	9.5
HRA15	Aluminium	15
HRA24	Aluminium	24
HRA30N	Aluminium	30

*Also available 42m HRA42 & 60m HRA60

Special Recovery Inertia Reel

While these units can operate as a normal inertia reel they are specifically designed to be located above the working area, with a hand chain to allow a simple method of raising and lowering the hook

Product Code	Housing	Length (m)
HRA15C	Aluminium	15

Automatic Lowering Inertia Reels

These inertia reels are for use when rescue/recovery operations pose a great risk. The device operates as a normal inertia reel with the added advantage of once arresting the fall, will safely lower the person to the ground. (Must only be used when no hazardous objects are below the user.) Recommended uses: Communication towers, power towers, water towers etc.

Product Code	Housing	Length (m)
HAS16	Aluminium	15
HAS30	Aluminium	30

B-Safe



HRA15P

HRA24



HRA15C



HAS16

D – Descent, Rescue & Confined Spaces Equipment

DBI-SALA Advanced PFAS (Portable Fall Arrest System)

For use on top of transformers or other types of platforms with potential fall hazards. A range of mounting bases are available for multiple applications as well as a detachable davit arm for use in rescue.

Product Code	Description
8516691	Portable Fall Arrest System
8516693	Rescue Davit Arm

Note: Mechanical devices and attachments sold separately.



DBI-SALA Advanced 5-Piece Hoist System

Designed for manhole and confined space entry/retrieval applications. The Davit pivots for ease of rescue and has an adjustment for overhead clearance restrictions. The lower base adjusts to fit most standard entries. A range of bases and masts are available.

Product Code	Description
8518000	Includes adjustable offset mast, lightweight lower mast and 3-piece lightweight base Also available in multiple size component configurations

Note: Mechanical devices and attachments sold separately.



DBI-SALA Advanced Side Entry System

Designed for confined space entry/retrieval and rescue operations involving horizontal entries with vertical positioning or retrieval required inside the space.

Product Code	Description
8511233	Side entry system package for use with external adjustment tank collar or permanently mounted bases
8511231	External adjustable tank collar

Note: Mechanical devices and attachments sold separately.



ROLLGLISS® Technical Rescue Range

NOWORRIES™

RIGMASTER™

RESCUEMATE™

ROPECRAFT™

OZPOD™

EXPLORER™



The ROLLGLISS® Technical Rescue Range is suitable for rescue personnel, from descent systems to rescue rigging systems, and also includes a wide variety of accessories. Please contact your closest Robertsons branch for further information.

D – Descent, Rescue & Confined Spaces Equipment

DBI-SALA Advanced Bases and Mounting Options

DBI-SALA Advanced portable and Fixed bases work with a variety of davit arm and mast extensions to suit a variety of applications.

Fixed Bases are ideal for work areas where frequent set-up and tear-down is required and a base can be permanently installed to an existing structure.

Portable Bases are ideal when you need to move and access various confined space areas.

Product Code	Description
Fixed Bases	
8518348	Wall Mount Sleeve (Stainless Steel)
8510316	Flush Mount Sleeve (Zinc Plated Steel)
8512831	Centre Mount Sleeve (Zinc plated Steel)
Portable Bases	
8510323	Barrel Mount Sleeve (Zinc plated steel)
8510520	Manhole Collar (Aluminium)
Vehicle Hitch Mount Sleeve	
8510140	Provides a portable anchor point for confined space entry/retrieval, rescue and fall arrest systems. Various sockets, extensions and accessories are available. Please contact your local branch for further information.

A wide range of other fixed and portable bases in stainless steel and galvanised steel are also available, contact us for more information, or for assistance in determining the most appropriate base for your needs. For more information on the complete range of DBI-SALA Advanced Confined Space safety systems and options, contact Robertsons.

Rescue Systems

Product Code	Description
Rescue Deployment System Kits (RDS)	
RDS-050	All RDS kits include: kernmantle rope, karabiners, harness yoke extension, gripping handle and storage bag 50m system Also available in 75m and 100m lengths
Rollgliss® R250 Rescue Kits	
AG62501010	All R250 kits include: pole, line, pulley system, karabiners, anchorage slings and bags Also available in 20m, 30m and 50m system lengths
Rollgliss® R350 Rescue System	
R3503015	All R350 kits include: rope unit, pulleys, rope control device, lanyard for rope handle, anchor strap, karabiners and carry bag 15m system
R3503030	30m system
R3503030P	30m system, with pick pole
Rollgliss® R500 Rescue & Escape Device	
3343040AU	40m system, includes descender, rescue hub humidity resistant case, karabiners, pulley, edge protector, rope grab and carrying bag. Also available in stand-alone descender unit with or without a rescue hub and ladder bracket. Other system lengths available in 10m increments
Rollgliss® Rescue Ladder	
8516294	2.4m, includes 3 connecting karabiners
8516316	Accessory plate for mounting ladder to a davit arm or anchorage point
Rollgliss® R520 Rescue & Escape Device Kits	
3305001	5m system, including R520 twin brake descender, karabiner connector, kernmantle rope, attachment fittings and storage/deployment bag. Also available in 5m increments up to 40m and then 10m increments to 100m



D – Descent, Rescue & Confined Spaces Equipment

Rescue Systems continued

Product Code	Description	Impact indicator
3305020	5m retrofit system for use with Bucket Trucks, EWP's or Crane Housings, including R520 twin brake descender, connector, kernmantle rope and attachment fittings. Optional storage/deployment box with U bolt, tracer wire and R-clip available separately. Available in 5m increments up to 40m and then 10m increments to 100m	
	Rescue Positioning Device Kits (RPD) All RPD kits include kernmantle rope, slings, karabiners, gripping handle and storage bag	
3600050	15m travel, 3:1 ratio Also available in 23m and 30m travel lengths	
3602050	15m travel, 4:1 ratio Also available in 23m and 30m travel lengths and other ratios	
	Rescumatic® Automatic Descent Control Device	
3300000	Includes two rescue restraint straps and rope spool. Note: The Rescumatic system length is determined by the length of the cable. Cable must be ordered separately.	
	Self Rescue Descender System (SRD) All SRD kits include descender, kernmantle rope, karabiner (SRD1 series), with snap hook (SRD2 series), U bolt, storage/deployment box, tracer wire with R-clip, spacer and certification tag	
SRD1-20	20m system, SRD1 series Also available in 25m and 30m systems	
SRD2-20	20m system, SRD2 series Also available in 25m and 30m systems	
	Ultra-Lok™ RSQ	
3504555	15m dual mode self retracting lifeline with rescue function, stainless steel hook and cable	✓
3500100	Assisted rescue tool (for use on First-Man-Up™ pole)	
3500102	First-Man-Up™ pole (2.4-4.8m) with assisted rescue tool	



Spanset Gotcha Rescue Kits

Gotcha will provide rescue solutions/provisions for all your staff who wear Fall Arrest Harnesses with Shock Absorbing Lanyards as long as you are able to safely access their anchor point.

Product Code	Kit Size	Order Codes	Capacity in High Anchor Mode (m)	Capacity in Low Anchor Mode (m)	Weight of Kit (kg)
	Gotcha 50	GOTCHA KIT	Up to 17	Up to 13	7
	Gotcha 100	GOTCHA KIT 100M	Up to 34	Up to 26	11
	Gotcha 150	GOTCHA KIT 150M	Up to 51	Up to 39	15
	Gotcha 200	GOTCHA KIT 200M	Up to 68	Up to 52	19

SpanSet®



E – Engineered Systems

DBI-SALA Engineered Horizontal Safety Systems



UNI 16™ Synthetic Cable Engineered Safety System

Ideal for industrial, construction and specialist application.

- › 16mm cable with a minimum breaking strength of 7600kg
- › Uni-16 can achieve spans up to 30m reducing the number of structural penetrations
- › The need for fewer anchors protects the integrity of the structure
- › Non-abrasive cable, protects roof or fascia finishes during installation
- › Patented cable terminations allow use as an adjustable temporary solution
- › Ease of repair following a fall



UNI 8™ Stainless Steel Engineered Safety System with Surface Mounted Force Management Posts.

UNI 8™

Ideal for new building projects and refurbishments, and when working on a roof with a low pitch. Uni-8 offers customers a cost effective solution and is particularly effective when combined with SpiraTech™ Anchors.

- › 8mm SS cable with a minimum breaking strength of 3800kg
- › SS 316 Grade fittings
- › Load re-orientating intermediate brackets protect the attachment structure
- › In line energy absorbers reduce loads in the event of a fall and further protect the attachment structure
- › Span of up to 12m between supports



UNI 8™ Overhead

Ideal for industrial applications where there is minimal ground clearance and the anchorage point needs to be above the users head.

- › 8mm SS cable with a minimum breaking strength of 4200kg
- › Single span or multi span use
- › Up to 30m spans between brackets, reducing the need for structural supports
- › Energy absorbers reduce structural loading

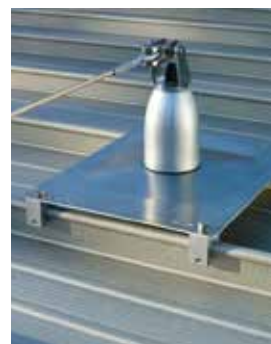

E – Engineered Systems

Unirail

Unirail Horizontal Safety System

The Unirail System is a rigid, extruded aluminium rail system that provides an extremely aesthetically pleasing and functional solution to modern fall prevention problems.

- > Multiple users
 - > Can be used for restraint technique, fall arrest and abseiling
 - > Can be bent/curved in both axis
- > No cable deflection calculations required in fall clearance
 - > Easy fixing methods to solid structural surfaces, and in any orientation



Roofsafe Rail

Roof Mounted Rail Safety System

Roofsafe Rail is the only direct to roof rail system that can facilitate changes in direction and roof slopes, eliminating the need for messy looking swing fall posts, anchor points and ropes.

- > Multiple users
 - > Can be used for restraint technique, fall arrest and abseiling
- > Curves available
 - > No cable deflection calculations required in fall clearance
 - > Fixing to metal roof sheeting using rivets or clamps



E – Engineered Systems



FlexiGuard® Access Systems

FlexiGuard® Access systems are AS/NZS, ANSI, CE, and OSHA compliant.

C-Frame Rail Fall Arrest System

A versatile system designed to be moved manually or with the use of a tow bar and service vehicle to provide safe access, horizontal movement and total fall protection on or near sensitive equipment for up to two users.



C-Frame Rail Fall Arrest System

A-Frame Rail Fall Arrest System

A secure anchor point in a portable structure giving the worker increased coverage and protection. Depending on the configuration, this system has the capacity to provide fall protection for up to four workers and can be easily moved from job site to job site.



A-Frame Rail Fall Arrest System

Counterweight Rail Fall Arrest System

Designed as a versatile solution to provide an overhead anchor point for up to two users while working at heights. These systems are designed to be counterbalanced by concrete or other means allowing for close positioning to the work surface without obstructing the equipment being accessed.



Counterweight Rail Fall Arrest System

Boxed-Frame Rail Fall Arrest System

Provides a convenient means of securing a fall arrest rigid rail in areas with limited space or inadequate overhead structure for up to four users.

These frames can be custom built to accommodate a specific area or piece of equipment. These units can be designed as a permanent or portable frame, allowing for easy relocation throughout a facility.



Boxed-Frame Rail Fall Arrest System

E – Engineered Systems

Ladder Fall Arrest System

Provides easy access to elevated work areas such as fuselage, wing and general maintenance areas with 100% fall protection from the ground up for up to three users, for the duration of the work being performed.



Portable Tanker Access Ladder System – Fall Arrest

Provides easy access to elevated work areas with 100% fall arrest rated tie-off for one operator from the ground up for the duration of the work being performed. System configurations may include but not limited to guardrails, SRL's or confined space entry equipment.



Portable Tanker Access Ladder System – Work Positioning

The Portable Tanker Access Ladder System (PTALS) combines easy access to elevated work areas with 100% fall protection and work positioning for one operator for the duration of the work being performed. System configurations may include but not limited to guardrails or confined space entry equipment.



K – Kits & Accessories for Height Safety Equipment

Harness Kits



Product Code	Description
BK061015	Roofers Kit with 2m Lanyard (most popular) BH01120 Harness, BL01112 2m energy absorbing Lanyard, BS010115A Rope and Grab, BP03101.5 Attachment Strap & BSK0001 Karabiner
BK061215	Roofers Kit with 450mm Energy Absorber BH01120 Harness, BL01000 pack, BS010115A Rope and Grab, BP03101.5 Attachment Strap & BSK0001 Karabiner
BK061515	Roofers Kit with Retracting Lanyard BH01120 Harness, BL05332.5 Retracting Lanyard, BS010115A Rope and Grab, BP03101.5 Attachment Strap & BSK0001 Karabiner
BK071000	Executive Height Safety Kit BH02030 Harness, BL05332.5 Retracting Lanyard & BP03001.5 Tie Off Adaptor
BK072000	Construction Height Safety Kit BH01120 Harness, BL01112 S/A Lanyard & BFK08 140mm Manulink
BK073000	Electrical Safety Kit BH05200 Harness, BL05332.5 Retracting Lanyard, BP02112.5 Pole Strap & BP03102 Attachment Strap



BK061015



BK061215



BK072000



BK061515



BK073000



BK0741000

K – Kits & Accessories for Height Safety Equipment

DBI-SALA Fall Protection Kits

Suited for specific worker applications, our kits include all the necessary components of the ABC of fall protection to ensure worker safety.

Product Code	Description
1900-0002	Cherry Picker's Kit , includes: Delta™ 321M-0018 Rigger's Harness with adjustable integral EZ Stop® lanyard, 1900-0000 Equipment/Kit Bag
1900-0004	Construction Worker's Kit , includes: Delta™ 380M-0018 All Purpose Harness, 3101000 2.4m Talon® SRL, Z90203636 EZ Stop® 2.0m Lanyard, E849-015 Tie-Off Adaptor, 1900-0000 Equipment / Kit Bag
1900-0005	Professional Roof Worker's Kit , includes: Delta™ 360M-0016 Roof Workers Harness, Z90103636 EZ Stop® 1.0m Lanyard, P6711-015-36-58 15m Rope and Rope Grab, R-105-S Screw Gate Karabiner, E849-015 Tie-Off Adaptor, 1900-0000 Equipment/Kit Bag
1900-0027	Professional Roof Worker's Kit without harness , includes: Z90103636 EZ Stop® 1.0m Lanyard, P6711-015-36-58 15m Rope and Rope Grab, R-105-S Screw Gate Karabiner, E849-015 Tie-Off Adaptor, 1900-0000 Equipment/Kit Bag
1900-0039	Live Line Kit , includes: Delta™ 305M-0019 Live Line Harness, Z95170606RPX EZ Stop® Live Line 1.7m Lanyard, Equipment/Kit Bag
1900-0047	Stock Picker's Kit , includes: 320M-0019 Delta™ Riggers Harness with dorsal extension, 3101009 Talon® SRL with stock pickers cab mount bracket and swivel snap hook, 1900-0000 Equipment/Kit Bag
1900324M	Delta™ Mine Utility Kit, Medium , includes: 324M-0019 Delta™ Riggers Utility Harness with dorsal extension, E404M Mine Utility Belt, 1900-0000 Equipment/Kit Bag. Also available in small, large and extra large sizes
1900404M	Exofit Nex™ Mine Utility Kit, Medium , includes: 603M1021 ExoFit NEX™ Riggers Utility Harness with dorsal extension, E404M Mine Utility Belt, 1900-0000 Equipment/Kit Bag. Also available in small, large and extra large sizes)



Product Code	Description
AA400AU	PROTECTA Roof Workers Kit PRO™ Climbing Harness (AB11343), 15m kernmantle rope lifeline with 0.55m integral shock absorbing lanyard, 1.5m anchor strap (AM500 / 150AU), backpack storage bag
AA1000AU	FIRST™ Roof Workers Kit First Fall Arrest Harness (AB17510AU), 15m Kernmantle Rope Lifeline with 1m Integral Shock Absorbing Lanyard, 1.5m Round Strap (AM450 / 150FAU), packed in a rugged re-useable Carry Bucket
AA410AU	PROTECTA Construction Workers Kit PRO™ Climbing Harness (AB11343), 3.3m Rebel SRL (AD111ARA), 1.5m round strap (AM450 / 150AU), backpack storage bag
AA1020AU	FIRST™ Construction Workers Kit First Fall Arrest Harness (AB17510AU), 2.1m Retractable Lanyard, 1.5m Round Strap (AM450 / 150FAU), packed in a rugged re-useable Carry Bucket



K – Kits & Accessories for Height Safety Equipment

Accessories

Product Code	Description
AK145	Lanyard cover
E810-DUAL	Yoke harness extension, dual, for rescue
E810-SINGLE	Yoke harness extension, single, for rescue
1150914	Tool safety strap, elasticated with choker tool loop and karabiner harness/belt attachment
E814	Tool safety strap, with tool clip and wrist choker loop
E815	Tool safety strap, with tool choker loop and velcro wrist fastener
E831	Dorsal extension, retrofit
E838	Utility pouch
E839	Lanyard stowage points
1000570	Derrick belt, for use with ExoFit NEX™ Derrickmans harness
1150011	Suspension seat, for use with ExoFit NEX™ climbing. For use with the Exofit NEC Climbing, Sit, Wind Energy and Derrickmans Harnesses
1150037	Dorsal webbing protector
1150174	Harness hydration system
9501215	Mesh harness laundry wash bag
9501262	Water bottle holder
9501263	Safety glasses pouch
9501264	Mobile phone pouch
9501403	Suspension trauma straps
9501207	Delta comfort back pad
CL002	Custom harness labels
1900-0000	Equipment/kit storage bag, standard
G029-3	Equipment/kit storage bag, large
G029-10	Harness storage bag

i-Safe™ retrofit tags are also available for use on all brands of harnesses, lanyards, self-retracting lifelines or other equipment such as gas detectors, tools, ladders & fire extinguishers that require inspection.

Product Code	Description
AK043	Duffel bag, 300mm x 500mm
AK066AU-BKP	Roofers kit backpack
G029-PRO	Harness storage bag
E839	Lanyard stowage points





BRISBANE SOUTH	4 Burchill St Loganholme, Qld 4129	P 07 3801 0811	E Sales.brisbane@jlr.com.au
BRISBANE NORTH	5 Johnstone Rd, Brendale, Qld 4500	P 07 3881 1445	E Sales.brendale@jlr.com.au
GOLD COAST	39 Dover Dve, Burleigh Heads, Qld 4220	P 07 5535 8277	E Sales.goldcoast@jlr.com.au
TOOWOOMBA	345 Taylor St, Toowoomba, Qld 4350	P 07 4634 6566	E Sales.toowoomba@jlr.com.au
MACKAY	179 Boundary Rd, Paget, Qld 4740	P 07 4952 5520	E Sales.mackay@jlr.com.au
GLADSTONE	4 Tranberg St, Gladstone, Qld 4680	P 07 4972 6511	E Sales.gladstone@jlr.com.au
SYDNEY	50 Skarratt St, Silverwater, NSW 2128	P 02 9748 3044	E Sales.silverwater@jlr.com.au
NEWCASTLE	33 Firebrick Dve, Thornton NSW 2322	P 02 4966 8622	E Sales.thornton@jlr.com.au
MUSWELLBROOK	49 Thomas Mitchell Dve, M'brook NSW	P 02 6541 5100	E Sales.muswellbrook@jlr.com.au
MELBOURNE	4/28-30 Little Boundary Rd, Laverton Nth, Vic	P 03 9315 1520	E Sales.melbourne@jlr.com.au
DANDENONG	28 Swift Way, Dandenong South, Vic 3175	P 03 9768 3244	E Sales.dandenong@jlr.com.au
PERTH	16-18 Kewdale Rd, Welshpool, WA 6106	P 08 9451 1522	E Sales.perth@jlr.com.au

www.lifting.com.au